

The Core Family

The Core family line offers a rich diversity of technical and aesthetic options. Our 3" round wall wash offers 14+ finishes & custom wood choices. A wide range of source/optic selections, 3 ranges of Ambient Dim™ (Warm Dim), and a plethora of driver/control options including TruPhase™ (phase dimming down to 0.1%). Our Core product family is created on platform allowing for a high degree of modification.

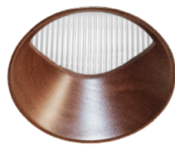
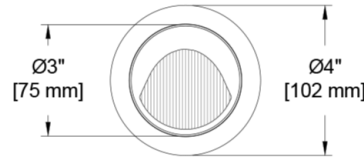
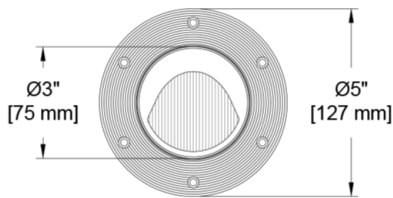
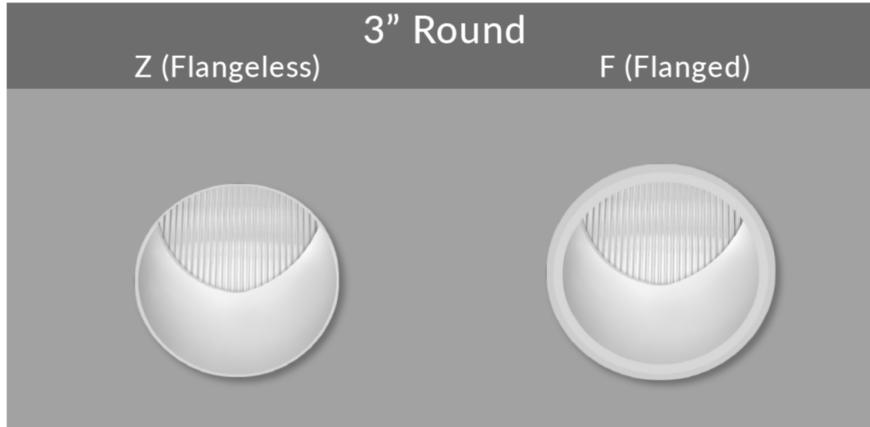

Available in Wood Trims

PROJECT:

TYPE:

SPECIFIER:

DATE:

Key Points (CR3WW-RF)

Trim

- Flange or Flangeless
- Supertex spread lens, hinged for source and driver service
- Flangeless includes plaster flange
- 14 color options + custom RAL or wood available
- One-piece die cast aluminum or machined wood trim

Source / Optics

- Lifetime: L87B3>55,000 hours at 40°C ambient
- 2400K, 2700K, 3000K, 3500K, 4000K Ambient Dim, RGBW & Tunable White options
- 90 CRI, 60+ R9 Standard- 95 CRI 90+R9 Optional
- <2 MacAdam Steps (<2SDCM) for fixed white
- Up to 914 delivered lumens (Based on 3000K CCT @ 90+ CRI)
- Uniform light from floor to ceiling. Achieves a 3.7:1 ratio on a 10' ceiling at 2.0' setback with a 1:1 on center spacing

Housing

- Compliant to with Airtight Housing (C14 source only)
- Listed – Damp or wet with shower trim
- Approved for 8 (4-in / 4-out) #12 AWG conductors rated for 90°C through wiring
- IC Rated / Airtight Housing approved for use in direct contact with insulation – Chicago Plenum Available
- Heavy gauge steel for new construction or remodel





Driver

- TruPhase™ - Dimming down to 0.1% - 120V only
- TruPhase™, 0-10, DALI-2, DMX, Lutron or Casambi
- Flicker free to IEEE 1789-2015
- Prewired and integral to housing
- Universal 120-277v

Ordering Codes

PROJECT: _____ SPECIFIER: _____
 DATE: _____ TYPE: _____ QUANTITY: _____

Ordering Code Example: CR3WW-RF-F-AU-C20-35-E2-P16-CP

FIXTURE	TRIM	MOUNTING	SOURCE / WATTS	CCT	DRIVER / CONTROL	TRIM FINISH	ACCESSORIES
<p>CR3WW-RF</p> <p>Core 3" Round Fixed Wall Wash</p>	<p>Z Flangeless Trim</p> <p>F Flanged Trim</p>	<p>ASPM * ● ● Airtight Shallow Panel IC-Rated</p> <p>ASP * ● ● Airtight Shallow Plaster IC-Rated</p> <p>ASU * ● ● Airtight Shallow Universal IC-Rated</p> <p>● ● Supports CA Title 24 Compliance</p>	<p>C10 10W 600Lm 90+CRI, 60+R9</p> <p>C14 ● ● 14W 916Lm 90+CRI, 65+R9</p> <p>Tunable</p> <hr/> <p>T9 90+CRI, 60+R9 Tunable White</p> <p>T15 90+CRI, 60+R9 Tunable White</p> <p>RGBW 90+CRI, 60+R9</p> <p>Ambient Dim™</p> <p>A8 ● ● 8W 586Lm 95+CRI, 90+R9</p> <p>A12 ● ● 12W 950Lm 95+CRI, 90+R9</p> <p>● ● Supports CA Title24 Compliance</p> <p>~See Photometrics chart for latest performance data</p>	<p>24 2400K</p> <p>27 2700K</p> <p>30 3000K</p> <p>35 3500K</p> <p>40 4000K</p> <p>Tunable</p> <hr/> <p>TW1840 1800-4000K Tunable White w/ E1, E2, E3, E4</p> <p>TW2765 2700-6500K Tunable White w/ E1, E2, E3, E4</p> <p>RG1280 1200-8000K RGBW Dynamic Color Changing *Requires E2 or E4</p> <p>Ambient Dim™</p> <hr/> <p>2722 2700-2200K * A14 Only</p> <p>3019 3000-1900K</p> <p>3022 3000-2200K * A14 Only</p>	<p>C1 0-10 1.0%, UNV (120-277V) linear</p> <p>C2 ELV/Triac 1.0%, (120V) linear</p> <p>E1 0-10 0.1%, UNV (120-277V) log</p> <p>E2 DALI-2 0.1%, UNV (120-277V) log</p> <p>E3 0-10 0.1%, UNV (120-277V) linear</p> <p>E4^ DMX 0.1%, UNV (120-277V) Universal DMX Driver/Controller RGBW-DMX ^ INCLUDES DMX/RDM COMPATIBLE DRIVER WITH BUILT-IN DECODER - CONTROLLER BY OTHERS (REMOTE ONLY)</p> <p>TR2 TruPhase™ 0.1%, (120-120V) log Up to 20W Forward and Reverse compatible Phase Dimming Static White & Ambient Dim only</p>	<p>W White Paint</p>  <p>B Black Paint</p>  <p>D Wood*</p>  <p>PXX Specialty Paint Color*</p>  <p>C Custom/RAL Color**</p>  <p>* Wood "D" selection to be used with Z trim and PM mounting - Refer to Wood Trim Guide</p> <p>** Refer to Finish Guide</p> <p>FINISH GUIDE LINK</p> <p>WOOD TRIM GUIDE</p>	<p>EM Emergency Pack Contact factory for options. Remote required.</p> <p>CP Chicago Plenum Controls</p> <p>ATH Lutron Athena Wireless Node Must be used with E2 driver</p> <p>CA Casambi Wireless BLE to be paired with driver</p>

Ceiling Cutouts and Dimensions

Round Flangeless Housing / **Panel Mount (Z/ASPM)**
CR3WW-RF-Z-ASPM-

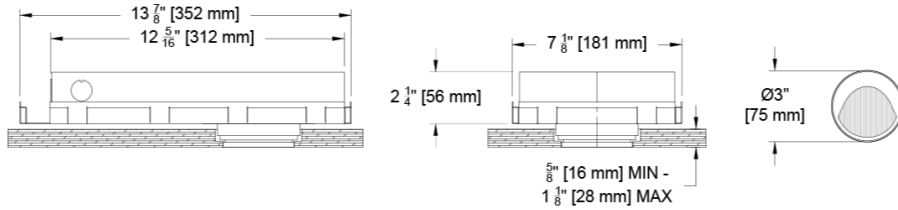
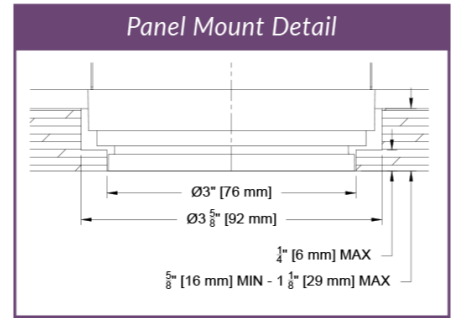

Round Flangeless Housing / **Plaster Mount (Z/ASP)**
CR3WW-RF-Z-ASP-

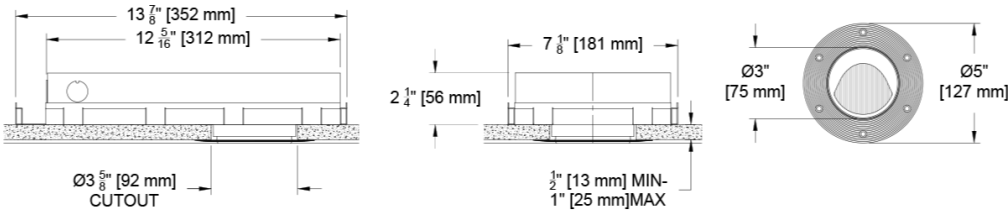
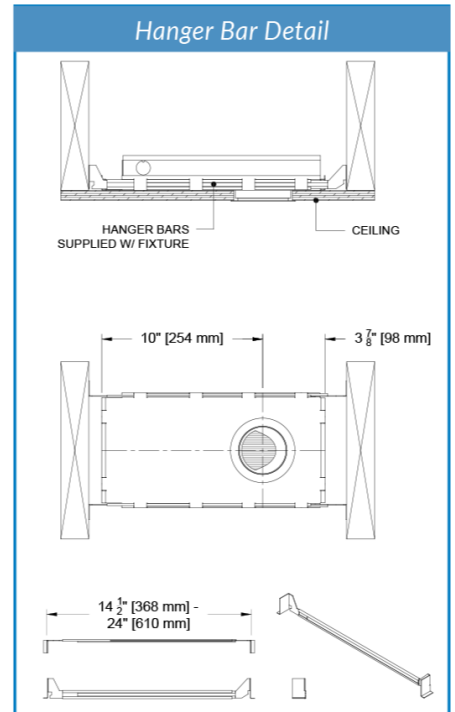

Round Flanged Housing / **Universal Mount (F/ASU)**
CR3WW-RF-F-ASU-

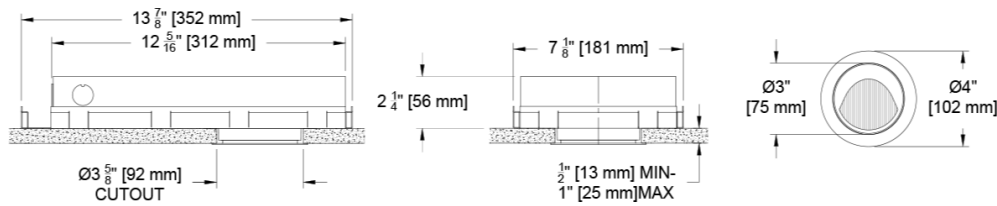

Color Data

All data is based from goniometer measurements of production representative product. All values can vary +/- 10% from LED manufacturer rated data range.

Citizen CoB C10, C14

- <3 MacAdam Ellipse (<3 SDCM)

94 CRI	66 R9
92 RF	103 RG

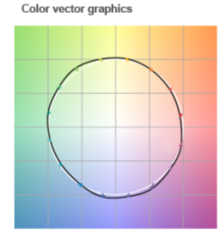
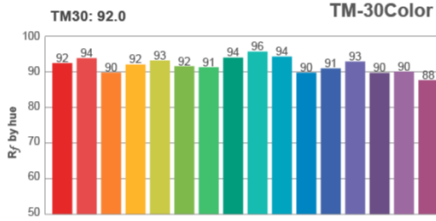
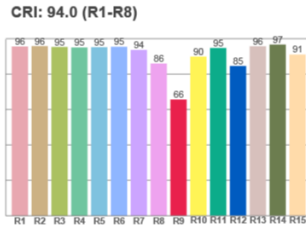

Spectra

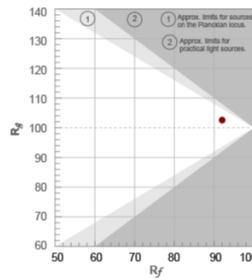
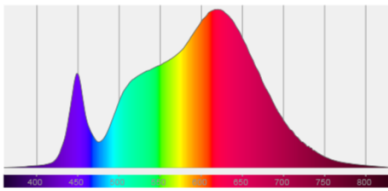

Color distortion

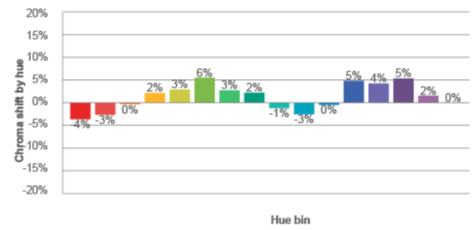

AmbientDim™ A8, A12

- <3 MacAdam Ellipse (<3 SDCM)

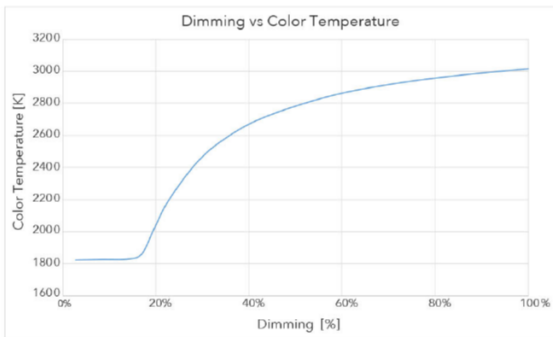

3000 CCT Full Output

97 CRI	98 R9	95 RF	104 RG
--------	-------	-------	--------

Spectra

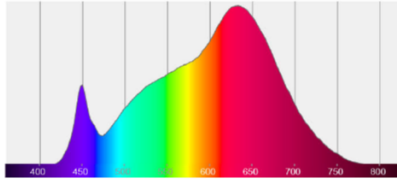

CRI: 96.9 (R1-R8)

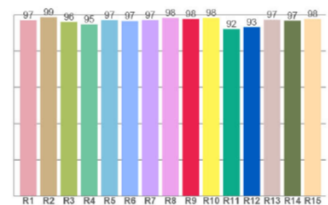

1850 CCT 5% Output

93 CRI	72 R9	83 RF	110 RG
--------	-------	-------	--------

Spectra

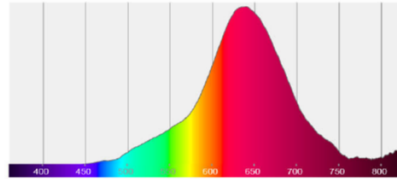

CRI: 92.6 (R1-R8)

